

## EINSTEIN IN PARIS

# Einstein Presents And Discusses His Theory

by Charles Nordmann



Einstein in Paris, 1922.

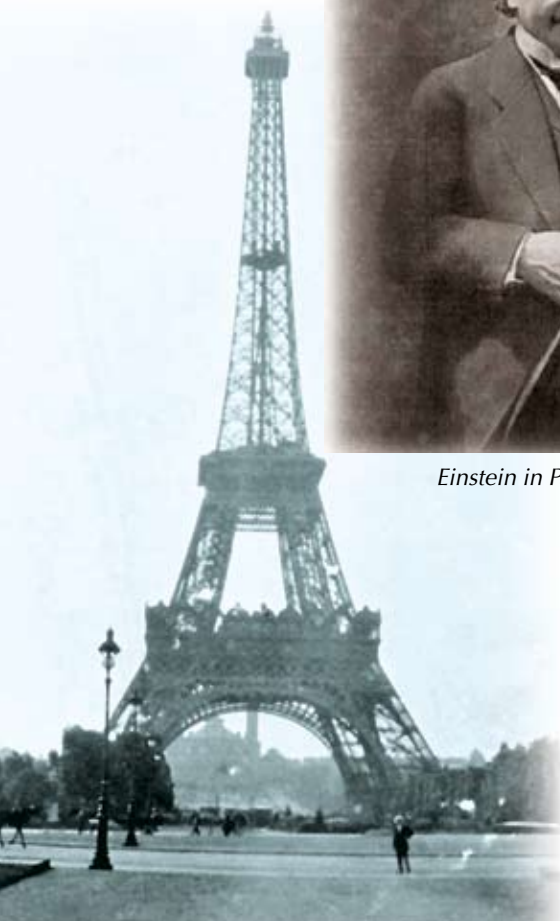

The recent exposition by Einstein on his work, along with the discussions which followed at the Collège de France, was without doubt an unprecedented event. The famous physicist took part in it with inexhaustible patience. One felt in him the desire not to leave any misunderstandings in the shadows, not to ignore any of the objections, but, on the contrary, to provoke them in order to better tackle and wrestle with them squarely.

In the United States, in London, and in Italy where Einstein was successively received some months ago, he limited himself to explaining the Theory of Relativity in a conference format. In the United States and in London, he preferred to speak in German because of his imperfect knowledge of English; in Italy, he expressed himself in Italian, which permitted a more intimate contact with the audience. But in all of those countries he limited himself to a “non-contradictory” monologue—if I may borrow this incorrect but colorful expression from our political language.

In Paris, on the other hand, Einstein was not satisfied with speaking didactically *ex cathedra*. He resolutely launched into the controversy, replying publicly in what was to become a most celebrated series of discussions, taking on all objections and questions asked by some of the most eminent representatives of the scientific community.

I thought that it would be useful to give, for these historic joustings of thought, an image as exact as possible and from which, nevertheless, the too-esoteric language of the technicians would be excluded.

### EDITOR'S NOTE

This is a translation by members of a LaRouche movement team of a 1922 article by Charles Nordmann describing several lectures by Albert Einstein during his visit to Paris that year. Nordmann's article, “Einstein Expose et Discute sa Théorie,” appeared in *Revue des Deux Mondes*, Vol. IX, pp. 129-166.

Charles Nordmann (1881-1941) was an astronomer and physicist, whose research and publications were well known in the science community and in the public at large. He was a laureate of the French Academy of Sciences and a Knight of the Legion of Honor. One of his books, *Einstein and the Universe: A Popular Exposition of a Famous Theory*, was translated and published in English in 1922 (New York: Henry Holt and Company).

Nordmann published frequently on scientific topics in *Revue des Deux Mondes* (*Review of the Two Worlds*), a French-language monthly cultural affairs magazine that has been published in Paris since 1829.

A translator's note appears on p. 21. Numbered footnotes are from the original article, unless specified as a Translator's Note. Illustrations have been added, as have very occasional translations of foreign terms (in square brackets). Emphasis is from the original.



*Astronomer Charles Nordmann, with the title page from the book he wrote in 1922, the same year this article appeared.*

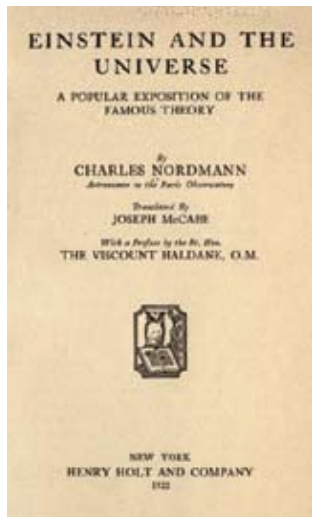

ed. That is what guided me in the pages you will read. In times to come, some years from now, it is probable that the intellectual controversies, which Einstein's presence in Paris provoked, during this fresh spring of 1922, will have greatly surpassed in importance the affairs that present times have thrust upon us. I would wager that in a few centuries—and what is that in the astronomical or even simply biological time of the planet?—the recent discussion on relativity in the Collège de France will have marked off a new step forward on the road of human intelligence . . . while the Conference of Genoa [1922] will be long-forgotten, like so many useless past arguments, and some still to come in the future.

At the Collège de France, the fact that the sessions had the good fortune of reflecting a tight discussion, rather than didactic lectures, originated from a desire on the part of Einstein himself, a desire inspired in him by his modesty, or better said in his lack of confidence in himself.

In fact, here is what he wrote in a letter, a few days before he arrived in Paris:

I will certainly have some difficulty expressing myself in French, but I think I'll be able to pull myself through, for

example by reading a prepared text. Furthermore, formulas also help a lot,<sup>1</sup> and I hope a willing colleague will be good enough to utter and extract the words that would get stuck in my throat.

It would perhaps be even more agreeable, and more useful if we were to have a sort of small congress on Relativity, in which I would only respond to questions. The difficulties of expression would annoy me less in this way than a more or less complete exposition of the theory.

As experience would have it, Einstein's fears were unfounded. At least for us they had been worth it, for these were the most passionate controversies one could possibly imagine, and they gave us hours of intellectual pleasure, as one too rarely has occasion to savor in the pedestrian monotony of this brief existence.

The merit of having brought success to these now famous sessions is not slight. It is due above all to Mr. Langevin, professor of experimental physics at the Collège de France, on whose request Einstein had been invited to Paris, as I have already mentioned. It is Mr. Langevin who oversaw the daily schedule of the small number of meetings, where so many subjects had to be covered. It was he who, with a firm and discrete hand managed to provoke the discussions, prevent the debate from leading astray, and restricted, whenever necessary but always with a well-chosen word, the exact positions of the adversaries. In rare but decisive moments, he also participated in the battle by helping the slightly wounded participants, or by giving the coup de grâce to those who were in such a desperate state that it was necessary to cut short their unnecessary suffering. Finally, it is he who played for Einstein the indispensable and difficult role that Einstein had asked for in his letter, the role of the intellectual Pylades, the informed cue-giver whose vocabulary and acute knowledge of the subject are never wanting.

The first session took place at the Collège de France, Friday

1. We must understand that Einstein speaks here of the language of mathematics which assuredly, with the aid of a blackboard, is the most international language . . . at least for the initiates, and the only one that dispenses with being multi-lingual.



*The courtyard of the Collège de France, with a statue of Guillaume Budé, who was a contemporary of Erasmus and Thomas More.*



*A modern view of the auditorium where Einstein spoke at the Collège de France.*

Here, presented for the first time in English, is a firsthand account of Einstein's historic trip to Paris, after World War I. Not only is it of interest to the historian of science or researcher of international relations, but this snapshot from a turning point in time provides any thinker with an example of how a genuine idea can be presented and honestly discussed.

Being a social creature might not be exclusive to the human species, but coming to know personalities that are long dead, is definitely unique to us and is a very special tool in helping us live up to our uniqueness. Becoming friends with one of humanity's geniuses of the past provides a fun study in discovering an expression of the potential of mankind, and provides a clear example of what the nature of an individual man is, as opposed to a monkey.

I have specifically picked Einstein as my "buddy." As Einstein's future, we are able to reap the ideas and method that he sowed (if we bother to know him and our history), in order to provide a new platform of culture and ideas for our future. I hope that this peek into the past will help foster that for you.

In distilling the significance of the human individual's creative capability, you quickly realize the effect the interaction of the highest level of mind can have on the development of society at large; you see the grander impact a life can have on the world, rather than an existence of being consumed by the daily soap opera of personal situations that are inconsequential in the scheme of things (unless, of course, they help you develop your individual creativity to be an effective world citizen.)

Original sources are the only way to get a living sense of a debate. Not only the papers a person wrote, but his letters, lectures given by contemporaries on the topic, newspaper articles, and so on. These shadows of a process give you a chance to immerse yourself in an environment to appreciate and rediscover for yourself the cultural effect an idea has.

In search for such a context of Einstein's development of hypotheses, I reached a road-block in my research. The Princeton University Press had been putting out the collected works of Einstein, articles and letters, but at this point had only reached the year 1920-1921. Just when things start to get good! Einstein's theory of gravity had just been publicly validated and therefore popularized, he was plunging into General Relativity's implications on the shape of the universe and its interaction with other principles, such as electromagnetism.

In reading biographies of Einstein, the event they speak of as most important in these years—the early 1920s—is not some scientific paper being published, but Einstein's trip to Paris. One of the intended destructive effects of World War I was to cut off international intellectual relations. Einstein's trip would be the first step in mending French and German relations. This created quite a stir and many people were not happy on both sides.

With such an important instance in scientific and political history, I was surprised that I couldn't find Einstein's speeches from this conference, but only thirdhand short ref-

erences to what was talked about. In contacting the Einstein archives, I was told that Einstein spoke informally, so there were no written notes from him personally, but the archivist gave me a date and the title of a journal for which a Charles Nordmann was commissioned to report on the event. I tracked it down and assembled a team to translate it from the French.

For more on the context of the political environment, please see Michel Biezunski's article "Einstein's Reception in Paris in 1922" in the book *The Comparative Reception of Relativity*,\* and an article by Nordmann in English on visiting battlefields with Einstein.\*\* Both are priceless accounts that help you appreciate the actual struggle intellectuals went through to make humanity stronger through advancement in thought; and the fact that science cannot be separated from politics, and should take a leading role in culture.

Nordmann's article gives a good picture of the circle which existed, both as supporters and critics, around Einstein in the debate on The Relativity Theory. How refreshing it is to see how an idea can be honestly fought over, instead of simply deciding to agree to disagree, or deciding that anybody who dissents from the prevailing opinion is crazy. What's unusual in witnessing the back and forth, is that the opposition side is competent, for the most part, and is genuinely seeking the truth. This provides a foil to the lack of true scientific debate today in a Boomer era.

If you can become accustomed to the flowery descriptive nature of Nordmann's writing, you'll find this article useful, not only for the on-the-ground reporting in the middle of the development of Einstein's thoughts, but also because it provides a good overview of the fundamental principles on which Einstein's theory is based, and the many paradoxes that seem to come up according to common sense when faced with relativity. Also it presents a fair approximation for a layman of Einstein's basic method of approach.

For example, one thread that comes up repeatedly in the article is the subject of math. Nordmann, on behalf of Einstein, is sure to make the point that math is not useful in and of itself, and is out of reality, unless it is the servant of physics. Another continuous thread is the discussion of the meta-physical vs. positivism. It seems that Nordmann is sure to qualify both sides and imply that there's a balance needed; but from the work of Einstein and my coming to know his discovery process, it is clear that Einstein is simply above the mystic or the data collector, which comes up when Einstein discusses Ernst Mach.

As with all secondhand (or even firsthand) sources, the value comes from what you are able on your own to put together of the process of mind of the individual characters on stage, and what's pushing the overall drama as a whole, as opposed to having a perfect map of what was discussed when.

Therefore, I humbly submit to you this translation.

—Shawna Halevy

#### Footnotes

\* Michel [Biezunski](#) on Einstein's reception in Paris, 1922.

\*\* Charles [Nordmann](#) on visiting battlefields with Einstein.

March 31st at 5 p.m., in this Amphitheatre VIII which, even though it is the largest room of our fine institution, is nonetheless ridiculously small. Long before this session began, the fortunately privileged crowd that was admitted to this unique event had filled all of the seats and was spilling over into the narrow passageways of this all-too-modest room where Einstein was going to speak. And all those who were in attendance had to agree on the certainty of at least one thing, that, at least for this place, the non-existence of space was quite certain. There were students, professors, scientists, all the elite of French science and of French culture, all the great names which honor this country. From the density of attendees, one might believe oneself to be at a famous session, where recently the idolizing public would be flocking to a lesson of a Caro or a Bergson. But in regarding the crowd a little more closely, the comparison is not quite justified. There were truly very few famous actresses or high-society ladies, in this gathering of dignitaries whose compressibility was put to such harsh trial. Here again, Mr. Langevin's extreme honesty was manifested. To the extent that we had been generous in the distribution of tickets to people in science and research, even to young students whose attendance was considered legitimate, in the same degree, we were merciless in rejecting all who could represent snobbery, ham actors, or simple idle curiosity. Also, all things considered, I'm not quite sure one could have been able to enumerate among this center of tasteful intellectuals a half dozen of truly elegant women. Within the decaying walls of this jewel box, where the purest diamonds of the mind were about to reveal their luster, not even an ingenious thief would have been able to steal sufficient jewels to merit the least newsworthy comment for the newspapers.

This was also very much in harmony with the tastes of Einstein.

But, all of a sudden, on the lower platform of the amphitheatre where a little desk surrounded by some chairs is arranged, here comes Einstein accompanied by Mr. Maurice Croiset, administrator of the Collège of France, and Mr. Langevin, followed by the professors of the Collège. The whole room rose to its feet in one movement and greeted the wise one with a terrific acclamation. Einstein seemed moved and anxious. In some perfectly succinct and chosen words, Mr. Maurice Croiset welcomed him and told him how proud the Collège was to have him here. What Mr. Croiset does not say, but which all the idealists of the country are thankful for, is the role that he personally played, and not without courage, in bringing Einstein to this venerable house, and which showed itself, one more time, to be deserving of its high, and free tradition.

In a few phrases, Einstein, standing the whole time, thanks us with his soft and singing voice, initially not very confident-sounding. In a cautious manner, he remarks that his presence in this place is the happy sign that science is no longer threatened by politics. Then, he sits down: The respectful room, which was also standing, does the same. Immediately, and without transition,—Einstein has no taste for oratory—he begins to speak to us about the Theory of Relativity.

His diction is slow. You feel that the words are not going fast enough to follow the rapidly advancing and well-ordered troops of his ideas. The voice is caressing, and of a rather low and vibrant tone. Henri Poincaré had also an extremely low voice,



*Albert Einstein and Prof. Paul Langevin in 1922.*

but its tone was still lower than that of Einstein. Einstein doesn't ignore any of the nuances of our language which he pronounces with a slight accent. He says "les équations," "la relativité," "la cinématique."<sup>2</sup> While he speaks, his eyes, with very inclined eyebrows above the eye-sockets, converging upon an "accent circonflex" [^] towards the middle of the forehead, seem directed very far away, much farther than the ardent looks of the public for whom he had become the geometric center. Those eyes, which they contemplate, are the serene regions where the mind of the scientist synthesizes the marvels of matter and energy. This ideal contemplation is not at all that of a dream: that which he scrutinizes are lively realities, which are impressionable things; because, for Einstein—and he will not stop insisting on these ideas which separate him from certain contemporaries of his—the mathematical abstraction is not at all some winged thing used to lead the mind wildly astray, it is and does not need to be other than, the humble servant of things, such as they exist in reality. From time to time, he leans towards Mr. Langevin who is seated to his left and a little bit set back, to get the necessary word, the French word which he is having difficulty, following his own expression, in "extracting from his throat."

Sometimes, it's an English word that comes to his lips, and I hear him murmuring "assumption" while Mr. Langevin softly whispers "hypothesis." But these short pauses, which sometimes slow down his delivery, are not disagreeable, because they give the audience member time to better piece together the reasoning; whose extraordinarily dense succession of arguments makes this presentation the richest melting pot of ideas that can be imagined. And then, as if to lighten the heavy ideas of his presentation, each time that the desired word doesn't

2. [Translator's note] This may not be clear to non-French speakers. The actual French spellings of these words, with accents, are *les équations*, *la relativité*, *la cinématique*. It would be as if a German speaker said in English "He said dat fery vell."



One of the many articles in the popular press reporting on Einstein's visit to France. *L'illustration* also covered Einstein's 1922 visit to a French village near Dormans (above), which had been destroyed in World War I.

come easily, Einstein smiles, while waiting for Mr. Langevin to deliver to him the desired term. And this smile that was so well captured by the artist Choumoff, has something extremely seductive to it. It seems to me that it has something of a courteous reluctance, like a prayer to not become angry at these small, purely philological hesitations.

Moreover, Einstein speaks without any notes, with his sight aimed high. His usual gesture is to slowly raise his two hands with the thumb and index finger touching softly as if he were extending and slackening successively an invisible thread, the supple and silky thread for the demonstration.

In this first meeting, Einstein declared at the beginning his desire to limit himself to a sort of general exposition of the principle of relativity, or rather of the method employed in the elaboration of the theory. The following meetings, he added right away, will be entirely set aside for discussion.

To tell you the truth, ever since this initial meeting, Einstein had, by his own presentation, launched the controversy and debated with the sharpest precision some of the criticisms which were leveled at him, and some of the misunderstandings that the controversy had created around the new doctrine.

I would not be able, here, to follow Einstein step by step in his presentation, which lasted two hours. It would take me several hundred pages to translate it entirely into a language where the technical expressions would be made accessible to the non-specialized reader, since the words and the phrases with which we can express these things unfortunately don't have any of the dense and concise brevity of mathematical formulas. That which can be said in five minutes, when we can talk freely of coordinate axes, quadratic forms, geodesics, and transformation formulas, would require much more time to express when we have to first translate these esoteric terms into ordinary language. In his purely didactic part, the presentation of Einstein had moreover simply consisted in recalling the essential bases of his theory, and the notions already known by those who do me the honor of reading my own writings.<sup>3</sup> This leaves out the

specifically critical and methodological part of the presentation which gives it its originality, and of which I now propose to express, in the simplest way possible, the profound interest and convincing conclusions.

The theory of Einstein is generated from problems that come from "experimentation." It is based on facts, and its author insists with much vigor on this point which has often been misunderstood. It is completely the opposite of a metaphysical system—and my readers remember that I have already developed this idea at length.

What are, therefore, the facts on which the new theory was

built, and which seemed, in some way, to compel its acceptance? The point is this: There is, in classical science, or in the study of mechanics, which was laid out by Galileo and Newton, a principle which is called the "principle of relativity," which comes more or less to the following: In the interior of a material system, we cannot in any way show its motion, via experiments done within a vehicle in uniform translation. For example, in a train moving uniformly, (and not taking into account the vibrations, which are precisely alterations in the uniformity of the motion) we cannot by any known process show the reality and the magnitude of the motion. When two trains pass one another (not taking into consideration these alterations), the passengers cannot know which is actually in motion, that is to say, each one believes that it is the other one which is in motion. All classical mechanics, all traditional science, is founded upon this very simple principle. It has been verified throughout centuries. Not only is it the result of facts, but it has in it a *je ne sais quoi* of evidence which satisfies the course of our reason. The latter in fact, repudiates the idea that there could exist in nature, among all uniform motions, that is to say among similar motions, some which could be real motions, that would exclude other ones.

The good intuitive sense and the facts combined, have therefore come to agreement in cementing on solid foundations the classical principle of relativity, as far as uniform motions are concerned. But, note that since the 19th Century, another edifice was erected in science, which is not concerned with the displacements of material bodies, but rather with the subtle motions of light and electricity. On the other side of mechanics was erected electromagnetism which not only combines in a superb *theoretical* synthesis, optics and electricity, but which has led to magnificent *experimentally* verifiable predictions; among the most beautiful are the discovery of the wireless telegraph and the proof that Hertzian waves travel at

---

Relativity, and, for General Relativity, I refer the reader to my recent little book *Einstein and the Universe*, where the conclusions are found to be (as one would judge) entirely in agreement with those found in the controversies which provide the occasion for the present article.

---

3. I may be permitted here to refer my readers to the articles where I have explained the experimental and theoretical foundations of the Special Theory of

the speed of light.

Electromagnetism reestablishes as a foundation this principle that the speed of light is constant in every direction.

But, observe that certain recent *facts*, certain experiments were shown to be incompatible, either with electromagnetism, or classical mechanics, or better still, with the two principles which serve as foundations respectively for these two disciplines, which are the principle of relativity and the principle of the constancy of the speed of light. The experiment of Michelson, among others, appeared to be leading to the necessity of abandoning either one or the other of these principles. This is when Einstein, through a profound analysis of the notions serving as foundations for classical mechanics, showed that this is deduced rigorously from the principle of relativity only if we allow for certain hypothetical entities which we call absolute space and absolute time.

If we eliminate these two hypotheses and if we define time and space, that is to say, extensions and durations as we observe them, by taking into account the non-instantaneous propagation of light, we then elaborate a new science of mechanics, the mechanics of Einstein, which is founded, like the classical one, on the principle of relativity, but which constitutes an application of this principle that is extricated from metaphysical hypotheses and from the *a priori* notions of absolute space and absolute time.

In a word, Einstein maintains the two principles that have been tested experimentally and which are at the basis of classical mechanics and electromagnetism. Solely by application of these classical principles, but which he purifies of their metaphysical refuse, he constructs a new science of mechanics without any special assumption. Then, it turns out: 1. that Einstein's science of mechanics accounts for both the facts explained by the old science of mechanics as well as this new one; 2. that it immediately solves the incompatibilities that the Michelson experiment had shown between mechanics and optics; 3. that it explains and predicts a number of phenomena, of *facts* pertaining to electrons and which escape the grasp of classical mechanics; that it accounts for certain old results that represented enigmas for traditional science, such as the Fizeau experiment.

As my readers will remember, I have



*French physicist Paul Langevin (1872-1946) worked closely with Einstein in science and politics.*

explained all of this extensively in this review. I will, therefore, only retain this: The ontogenetic examination that we have just made of this theoretical body called Special Relativity proves clearly that this first aspect of Einstein's work *has been elaborated on the basis of data given by experimentation.*

The Theory of Relativity accounts for all of the results of the traditional doctrine and only differs from it by the fact that it has eliminated from it all remaining metaphysical residues. No one will dispute that this makes it a superior science. There is nothing in science but that which can be measured, and it is surely better to base science on this, than on that which cannot be measured.

Therefore, when the newspapers announced, with a touching tone of unanimity, the arrival in Paris of the celebrated *metaphysician* Einstein, they were certainly delivering the most falsified of all possible inexact news that ever came out of the whining printing presses. Obviously we are all more or less metaphysicians, starting with the housewife who is concerned about what she will feed her husband for supper tonight because she makes the assumption that her husband exists, and therefore, she is making a daring metaphysical assumption from beyond the outside world. However, this being the case, we can ascertain that Einstein is truly the least metaphysician of all physicists. His merit and the cause for scandal to the misoneists comes precisely from the fact that he has, better than anyone before him, de-metaphysicized the domain of science.

One of his constant preoccupations is to make clearly understood his particular concern in this respect. In his presentation of March 31st, and with the finesse-filled implications that characterize him, he explained this point extensively by addressing a particular species of metaphysicians known as mathematicians, that is, the pure mathematicians who, lost in their abstract dreams and carried on the powerful wing of their imaginations toward some unreal beauties, never put their foot down on the rigid soil of *what exists.*

Einstein certainly does not hold mathematicians in contempt. Without their collaboration, he probably would not have been able to bring his work to fruition. It is the absolute differential calculus of Ricci, the equations of Levi-Civita and of Christoffel-



*For a further explanation of Einstein's mechanics, see the video "[The Genius of Albert Einstein](#)."*



Nimitz Library, U.S. Naval Academy, Special Collections and Archives

Physicist Albert Michelson (1852-1931).



fel, and the geometries of Gauss and Riemann which, when used judiciously, allowed him to complete his work. But, he refuses to consider that calculating is anything else but an instrument, that is, merely a bridge between his experimental premises and the lawful conclusions of experimentation. He wants mathematics to be the servant of the facts. Always and above all, he is preoccupied with the physical significance of mathematical symbols. Those who have seen in the Relativity Theory merely the mathematical apparatus, are like the passers-by who would mistake Trinity Church for the gigantic scaffolding that hides its harmonic lines, and which might otherwise even somewhat contribute to its strength.

This is one of the most frequent misunderstandings that has arisen between those who consider the Einstein theory as a purely physical theory, and there are a few of us who for a long

time have held that point of view, and a number of those who are his mathematical adversaries.

Einstein stood up with force against the often-expressed opinion that the Theory of Relativity is nothing but a purely formal construction. It is a physical theory, a theory of the outside world, a theory of the phenomena, of the events occurring in the universe. He said the following in his own words:

Many mathematicians do not understand the Theory of Relativity although they may apprehend its analytical developments. They are wrong in seeing simply formal relations and of not meditating on the physical realities to which correspond the mathematical symbols in use.

Here is an example which, I think, will help us understand this conception. If a man who has learned nothing else but mathematics were to live his entire life inside of a closed room, he would be perfectly capable of reading and understanding the logical sequence of the formulas of a treaty of celestial mechanics. But, he would otherwise understand nothing of the celestial mechanics, because he would fail to understand that these formulas apply to the relative motions of real external objects that we call the stars. It is to this sort of man—due allow-

**Figure 1**  
**FIRST MICHELSON-MORLEY INTERFEROMETER (1881)**

A. A. Michelson's instrument, constructed in Berlin in 1881, for detecting the relative motion of the Earth through the presumed stationary ether. The two perpendicular arms are rotated so that one points in the direction of the Earth's rotation. Half-silvered mirrors at the center create equal path lengths for the light ray in the two orthogonal directions. It is expected that the light ray moving against the ether stream will take slightly longer than the ray which traverses the other perpendicular arm. This will be evident as a shift in the fringe pattern in the interferometer positioned at e.

*Inset shows the fringe patterns in narrow and broad magnification from a later interferometer.*

Sources: A.A. Michelson, 1881 "The Relative Motion of the Earth and the Luminiferous Ether," *Am. J. Sci.*, Vol. 3, No. 22, pp. 122, 124. D.C. Miller, 1933, "The Ether-Drift and the Determination of the Absolute Motion of the Earth," *Rev. Modern Phys.*, Vol. 5, p. 211 (July).

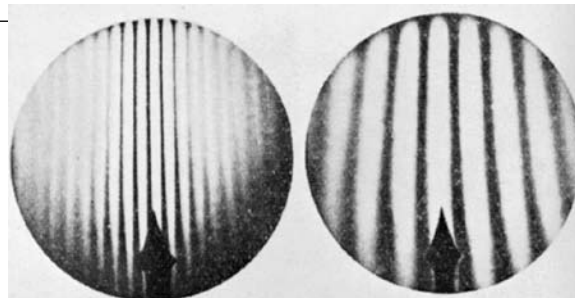
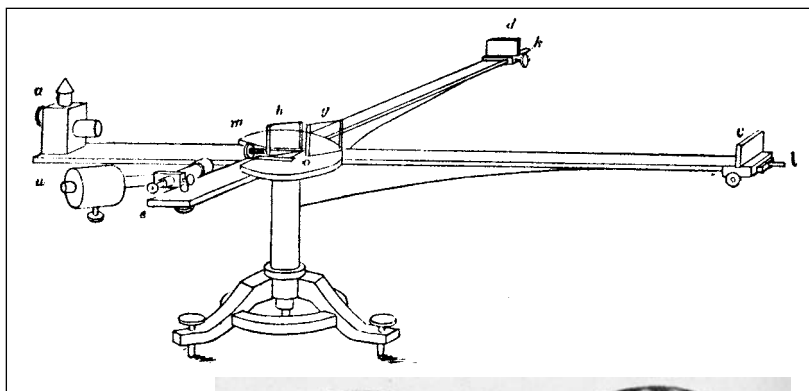

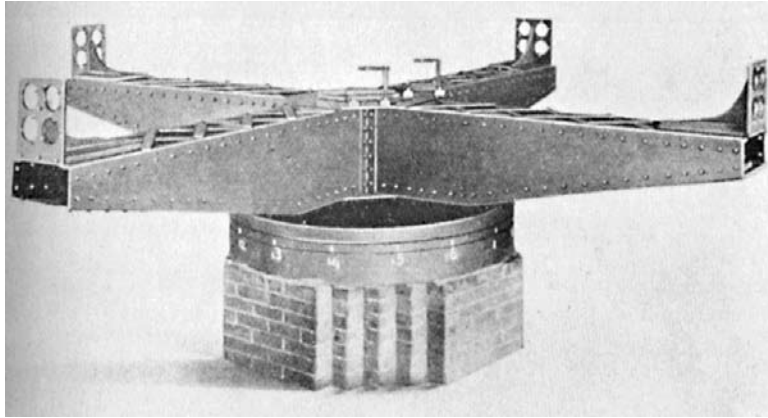

Nimitz Library, U.S. Naval Academy, Special Collections and Archives

*The Michelson-Morley experiment of 1887, set up in the basement of Adelbert Hall, Western Reserve University. Results were smaller than expected, though not completely null—an enigma to this day.*

*(For more on this topic, see “Optical Theory in the 19th Century and the Truth about Michelson-Morley-Miller,” by Laurence Hecht, 21st Century, Spring 1998.)*

ance being respectfully made to save their reverence—that Einstein will tend to compare those individuals who criticize his theories without having studied deeply enough their physical content.

Well then, the physical content, which is the basis for the entire Theory of Relativity, is the existence and the invariance of a quantity measurable with rulers and clocks, a quantity that we call the interval between things and which is neither their distance in time, nor their distance in space, but—my readers will remember—a sort of conglomeration between space and time.

The entire Einstein synthesis is founded on the belief of the real existence of this physical concept. If this concept does not exist—and this is conditional on experimentation and on the instruments of the physicist—the entire theory becomes nothing more than a play of mathematical formulas and vanishes. But, Einstein seems to be untroubled in this regard and we have to recognize that his tranquility is buttressed by solid demonstrations. Aside from all the verifications of classical mechanics that also verify Einstein’s mechanics, it is the admirable *experimental* verifications of physical discoveries (distortion of light by gravitation explaining the anomaly of the planet Mercury) that have led to the new theory.

As he was speaking on these things, and because of his imperfect mastery of the French language, Einstein had a few verbal hesitations and he treated us to some inspiring flavorful neologisms. For instance, when speaking about classical mechanics, which differs from his own as does the static chrysalis from the fast moving butterfly, Einstein came up with the new expression of “‘antique’ mechanics.” I asked myself if the use of this improper qualification did not mask a little bit of deliberate irony.

It is not only Special Relativity which is based on the necessity of resolving problems posed by experimentation; it is also the case for General Relativity, which represents the admirable crown of his theory. In particular, almost the entire synthesis was triggered by the following fact that classical science had noticed, but was incapable of explaining, and in which Newton

had only seen a coincidence: The numbers which express the weights of different bodies (that is to say, their reaction to gravity) are identical to those that express their inertia (that is to say, their reaction to some mechanical displacement). When we find similar types of identities in nature, such singular facts, it is natural that we seek to elucidate the matter differently than by simply saying that it is an unbelievable and fortuitous coincidence. That was nonetheless what Newton resigned himself to accept. This is something that Einstein was not resigned to accept at all, and his stunning penetration found the solution to the enigma in the theory of General Relativity, which brought together into a grandiose and unique synthesis these two domains

of gravitation and mechanics between which classical science had erected an unjustifiable barrier. The facts, and nothing but the facts, are at the origin of Einstein’s doctrine.

Again, it was by meditating more profoundly on perceived realities and on the experimental foundation of geometry which was carried out before him, that Einstein



French physicist Hippolyte Fizeau (1819-1896)

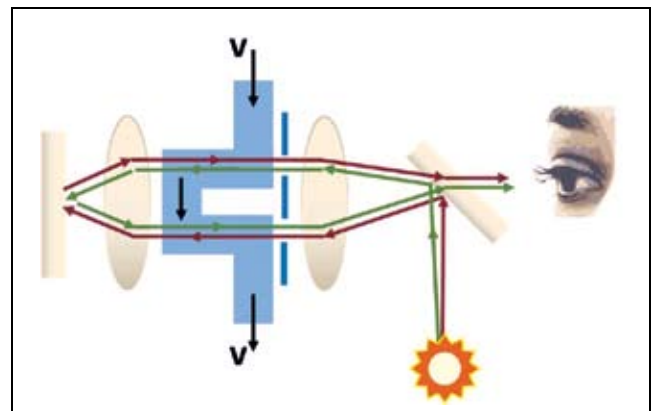

Figure 2

**SCHMATIC OF A FIZEAU INTERFEROMETER**

*Fizeau used his interferometer to measure the effect of movement of a medium upon the speed of light. He passed light in two directions through moving water, and measured the interference pattern. Both beams travel the same distance, but one goes in the direction of the water flow and the other goes in the direction opposing the flow. An interference pattern is formed (caused by the time differences of the beams) when the two beams are recombined at the detector.*





Henri-Louis Bergson (1859-1941) in a portrait painted by J.E. Blanche in 1891.



Emile Roux (1853-1933) was a French physician, bacteriologist, and immunologist who collaborated closely with Louis Pasteur.



Polish-French physicist and chemist Marie Skłodowska Curie (1867-1934), in a photo taken around 1920.

arrived at the conclusion that the world in which we live is barely approximated by Euclidean geometry. This conclusion has also been confirmed by the *facts*: such as the bending of light rays by a massive body, etc. I have already explained these things, and I want to stress only this: The Theory of Relativity starts from sense-perception realities in order to lead to other sense-perception realities. Mathematics, however considerable its importance, its logical rigor, and its unique mode of expressions may be, only plays a role that is analogous to that of transmission belts in machine-tools. That is the reason why Einstein never stopped riveting himself to the real world, to the data. Better than Newton himself, he has applied the *hypotheses non fingo*.

The Theory of Relativity is the most profound and the most successful of all attempts by the human mind to ban from science what is not measurable, and to chase out of physics all that is metaphysical.

Such was the impression made upon us by Einstein on March 31st after he had ended with a few cosmological considerations, on which I shall return later. He made a penetrating exposé divested of any pretense, whose sole eloquence streamed from facts and from reason. Then, the great physicist stood up in the midst of applause.

\* \* \*

The first discussion session took place on April 3rd in the physics amphitheater of the Collège de France, which is even more cramped than the “large” amphitheater in which Einstein spoke the previous Friday. The audience was composed almost exclusively of scientists, of philosophers, of researchers—and in the first among their ranks was Doctor Roux, his pale ascetic face capped with his small traditional skullcap, Mr. Bergson, Mme. Curie, and a great many members of the Academy of Sciences.

The session was to be dedicated exclusively to questions raised by the Special Theory of Relativity. Einstein was seated next to Mr. Langevin in front of a small table, to the side of a gigantic blackboard which would soon reveal the dialectical passion of the players.

The first question was on the Michelson experiment. My readers have not forgotten that, according to the Special Theory of Relativity, the length of a given object and the time separating two events are characterized by quantities which vary with speed, and which vary in such a way that the lengths and the durations (expressed in seconds) are shorter for a given observer when the objects under consideration move very quickly with regard to the observer. As far as lengths are concerned, I have even given an elementary explanation here. As for the times, an analogous explanation can be produced; but during this presentation, Einstein gave another demonstration of this fact, which was so simple that I simply cannot restrain myself from reporting it here.

It is known that light plays a fundamental role in the regulation of timepieces and the very definition of time; that there is no better definition for the duration of one second than the time necessary for light to traverse 300,000 kilometers, and that it is light or electricity (which has an equal speed) which are the practical agents for the synchronization of clocks. Let us therefore assume that the identity of time be defined by the time taken by a light ray to make a round trip along the distance between two parallel mirrors upon which the ray reflects normally. This going and coming of the ray situated between the two mirrors is an example of the type of periodic phenomenon by which time is measured out. It would, for example, define a three-hundred-millionth of a second, if the distance between the two mirrors is 50 centimeters. Such would be the value of the duration as considered by an observer situated between the two mirrors.

Now let us assume that the system containing the two mirrors passes before me at a very great speed, carried by a rapid translation, parallel to the two mirrors. I, who see it pass by, remark that the light ray, which leaves the center of the first mirror, must, in order to run to the center of the second, and from there back to the first, traverse a path slightly inclined in the direction of the translation and not normal to the mirrors. It follows that this trajectory, which defines the unit of time for the observer connected to the mirrors, defines for immobile me a time longer than my own unit of time. In other words, the durations of phenomena, the ticking of clocks, like all the gestures made in a vehicle in very rapid movement, will appear to be slowed down, and consequently appear prolonged to an observer in motion, and *vice versa*. Q.E.D.

In the course of his explanations, Einstein was led to specify that although the apparent contractions of objects by speed is deduced directly from the Michelson experiment by the theory, the apparent slowing of time follows from this experiment only indirectly. Experiments will perhaps someday permit time-contraction to be deduced from the observations of positive

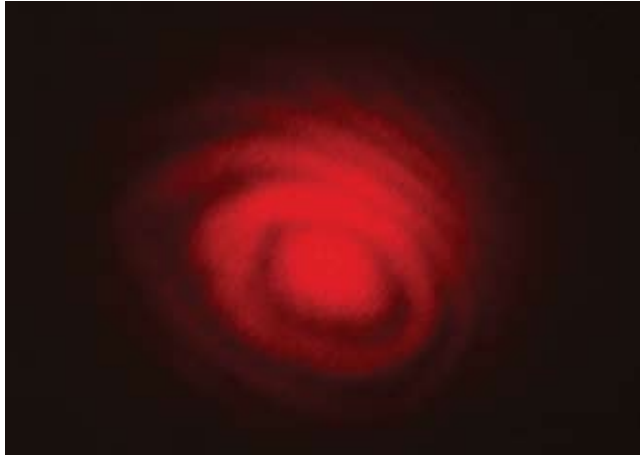

*The interference pattern produced with a Michelson interferometer using a red laser.*

rays [ions] or from the observation of the eclipses of Jupiter's satellites. But the precision of astronomical observations seems insufficient at the present time to establish the latter.

The principle and most certain demonstration of time-contraction caused by speed is found, as for distance-contraction, in the many indirect yet mutually agreeing verifications, which constitute the applications of this notion to the new mechanics and the verifiable consequences that it entails.

In regards to the Michelson experiment, Einstein has since recounted to me, that the famous American physicist told him one day: "If I had been able to foresee all the results that have since been derived from my experiment, I tend to believe I would never have performed it." It is incidentally something rather singular and very interesting from a historical point of view to consider this attitude of the principal precursors of Relativity when presented with the theory of Einstein. During the course of a recent conversation, Einstein gave me some curious clarifications on this subject, the essential elements of which I find useful to summarize for the reader here.



*French mathematician, physicist, engineer, and philosopher Henri Poincaré (1854-1912).*

Henri Poincaré has died, and it certainly would have been a profoundly moving thing to see Einstein discuss with this powerful mind, who had on so many points shown the way. Would he have been a partisan of the General Theory of Relativity? It is probable, but not absolutely certain. Studying the many famous pages on the origins and foundations of geometry, Henri Poincaré had arrived at the conclusion that, if it is not more ideally true than the others, Euclidean geometry is that which corresponds to the nature of the external world and to our sensations. On

this point Einstein made a clean break with the ideas of Poincaré, starting from the day he forecast the curving of rays of light by gravity, which was recently verified, as we know, and as Poincaré had not imagined.

That is the keystone of all Relativity, the central point from which Einstein was able to deduce that the real geometry of the world is indeed a non-Euclidean geometry. It is quite difficult to know what Poincaré would have thought about this. Surely under this form or perhaps another, he would have been, in keeping with his own ideas, a full relativist; and he would certainly have accepted with total sympathy anything which would have permitted him to live without these mysti-

cal creatures which he found singularly repulsive: the notions of absolute space and of absolute time of Newton.

Perhaps even more than Poincaré, Einstein admits having been influenced by the famous Viennese physicist Mach (who had first discovered and studied the shock wave that rapid projectiles produce in the atmosphere.) Mach formerly strove to reduce all of mechanics to observable phenomena, all motions to material references and supports. Although he was not able to bring his ideas to maturity due to his lack of mathematical and philosophical tools, they are in complete harmony with the very principles of Einstein. However, just before his recent death, Mach declared his hostility toward the General Theory of Relativity. "But it is because he was old," Einstein told me, smiling.

As for Lorentz, who is incontestably the most certain precursor of Einstein, it appears that he admits the foundation of General Relativity, while at the same time refusing to accept the principles which established the basis of Special Relativity. However illogical this attitude may seem to be, it is not shocking if one recalls that Lorentz always defended the thesis of the absolute and immobile ether, and the actual speed-contraction of bodies. His overall attitude regarding Relativity is, as one could judge, similar enough to that of Mr. Painlevé. But, as of now, it is important to note that to admit General Relativity is the same as admitting the essentials and majority of Special Relativity, since the former was only created by Einstein to remedy the shortcomings of the latter; which today, moreover, it subsumes in a more general synthesis. If you take the greater, you get the smaller as well.

The conclusion of this first controversial session, and the beginning of the following session (which took place on April 5th), were almost entirely taken up by a passionate discussion provoked by Mr. Painlevé, who, to the delight of his friends, had

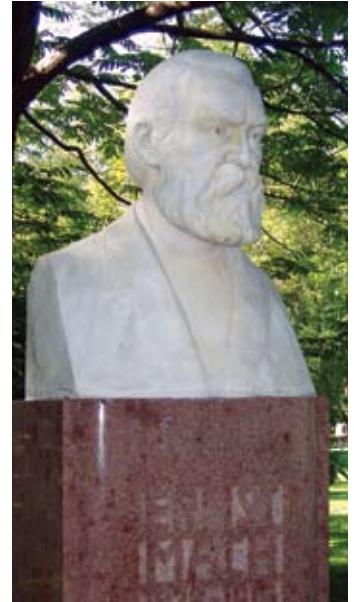

*This bust of the Viennese physicist and positivist Ernst Mach (1838-1916), sculpted by Heinz Peter, stands in the City Hall Park of Vienna.*



Museum Boerhaave, Leiden

*Dutch physicist Hendrik Antoon Lorentz (1853-1928) photographed with Einstein in Leiden in 1921.*

abandoned politics for a few hours. This discussion greatly contributed in definitely clarifying one of the most delicate points of the Theory of Special Relativity.

This animated and always courteous discussion was a most curious and interesting spectacle to watch in its perfect objectivity. In truth, Mr. Painlevé never ceased to publicly praise, on all occasions, his admiration for Einstein's genius. It was within a few weeks that a position of corresponding membership for the Mechanics Department had become vacant at the Academy of Science, and for which a few voices called for Einstein, who was neither a candidate, nor even presented himself. Mr. Painlevé was pleased to declare that his voice was among them. It was at this occasion that a highly esteemed member of the Academy proclaimed these delicious words: "How can you nominate Einstein as a member of the Department of Mechanics when it is Einstein, himself, who has destroyed the science of mechanics?" If it is true that all progress, all change, constitutes, in some way, a destruction of that which is modified, it is a natural tendency for many men to consider this destruction as necessarily bad. The same thing occurred when the Copernican system *destroyed* the Ptolemaic system, when Lavoisier's chemistry *destroyed* the old doctrine of Phlogiston. But it is, alas, the very nature of life's progress that it only grows and thrives upon destruction. The

butterfly doesn't leave its cocoon; the bird doesn't hatch from the egg without destruction. Man doesn't become an adult without the death of that which made him a child. No flower would blossom that didn't first rupture the fragile envelope of its bulb. This is also the history of the Einstein doctrine. Unless you wish to see the universe seized within a monstrous lethargy, and ideas crystallized forever into rigid forms, whose immobility would be the equivalent of death, one must be resigned to accept, especially with science, that the only *raison d'être* is to strive always further.

Thus, Mr. Painlevé never ceased to praise Einstein as one of the greatest geniuses human history had ever seen. I know, that for his part, Einstein professed the most sincere admiration for the work of this famous French geometer. In these circumstances, the atmosphere in which the conversation between these two scientists opened, was infinitely propitious to the happy shocks that confronted and animated these sincere intellects and from which more light was shed.

Nothing was more amusing than seeing Einstein and Mr. Painlevé side by side in front of the blackboard: the first always calm, armed with the soft patience which comes with absolute security; the second, impetuous and lively, boiling with the effervescence of ideas and arguments; the first immobile, the second never remaining in one place and always going back and forth within the narrow arena in front of the board. Einstein was pale and his attitude and manner of speaking seemed to resemble the inflexible solidity of an immovable rock, resisting over centuries the forces of erosion; Painlevé was all flushed by the flux of his boiling blood, passionate in his gestures and arguments, attacking with the sudden outbursts of unpredictable and brilliant fits and starts that we usually witness in assaults against old and shaky things, with the idea of turning accepted order upside down.

Just by judging the appearance of these two men, who, armed each with a piece of chalk, covered the vast blackboard with battalions of their opposed equations, it truly seemed as though it were Einstein, who was the conservative, and Mr. Painlevé, the "revolutionary." And yet, oddly enough, the opposite was true. It was the first who had completely overturned the entire edifice of the traditional structure, where the human spirit had dozed with a false sense of security, whereby the second acted as a rampart in front of the fortress of Newtonian science that was under attack.

The discussion was focussed on an important point about the Theory of Special Relativity. It ended—as we shall see—with a complete agreement between the two challengers, and served to completely eliminate a misunderstanding which this first level of the Einstein monument could have born in some minds.

Here is how, I believe we can present, without the use of a single formula and without any esoteric calculation, the question that was raised and the response that was given to it:

We know, as I have explained in the past, that because of the particular propagation of light, there exists no universal or ab-



*French mathematician and Prime Minister Paul Painlevé (1863-1933).*

solute time, and that the workings of two identical clocks would not appear identical to an observer attached to one of these clocks, and who sees the other passing by him at a very fast speed. As I showed earlier, the clock which is not moving with respect to me seems to go faster than that one which was moving speedily by me. In a general manner, the duration of events, such as the vibrations of a diapason, the beats of a heart or all other given phenomena, will appear shorter, more hurried, to a non-moving observer of these phenomena, than to an observer, in front of whom the vehicle on which those phenomenon are located, passes by quickly. For this last observer, these phenomena will appear to be slower. In a word, for a given observer, each vehicle in motion in space has its own particular time, its particular speed in which flow the phenomena. This time, this duration of a given phenomena (e.g., the burning of a cigarette), would seem always greater, when the phenomena are moving at a greater speed, in relation to me. Consequently, this time, this duration, has for me, its smallest value, when the speed is null, that is to say when I am attached to the vehicle in which the observed phenomenon is occurring. This minimum value of time, we shall call the *proper time* of the vehicle, and this expression is legitimate since it designates the time indicated by the proper clocks which are in the vehicle.

All of this is the necessary consequence of the stated laws of the propagation of light, and constitutes one of the foundations of the Theory of Special Relativity.

This said, we have here, reduced to its essential elements, the question raised by Mr. Painlevé and which at first sight, seemed to drive toward a contradiction, a paradox.

Consider a rapid train which passes through a station at full speed and continues its route with the same prodigious and uniform speed. This train has within it an identical clock to the one which is in the station. At the precise moment when it passes the station, the conductor of the train, who we may suppose (harmless hypotheses cost so little) is a skillful physicist equipped with all of the perfections of technique, who had managed to set the train's clock in sync with the station's clock at the instant that he saw this clock passing, that is, by the intermediation of light rays.

After having run the train for as many kilometers as we wish at the same prodigious and uniform speed, with his clock thus regulated, Mr. Painlevé supposed that the train suddenly stopped, and, suddenly, ran backwards, that is to say, returned towards the station, always with the same speed, but now driven in reverse. Now, we can calculate in these conditions (knowing the number of kilometers traversed by the train) the exact time marked on the clock [on the train] as it re-passes the station and the exact time marked off on the station's clock. In making this calculation, we find that at the precise instant when the train re-passes through the station, the clock in the train marked a shorter time than the station's clock, as this can be noted at the instant of passing by the station chief and the conductor, as the two clocks cross paths and are visible simultaneously.



Further explanation of Einstein's clock on the moving train appears in the video "The Genius of Albert [Einstein](#) .

In other words, if, at the moment the train crossed the station for the first time, the station's clock and the train's clock both indicated the time of noon sharp, or twelve hours, zero minutes, zero seconds, zero millionths of a second, this synchronization would no longer exist upon the train's return to the station. If the clock on the train indicated, say, 1 p.m. and zero millionths of a second, the clock in the station would indicate at the same moment (defined by the passage of the train through the station), 1 p.m. and some millionths of a second. We indeed assume, I repeat, two clocks of identical construction. In other words, the *proper time* elapsed between the train's two successive passes by the station would be shorter on the train's clock than the station's clock. The station chief would have also grown older than the train conductor during this interval. Thus, if we could sufficiently prolong the length and the speed of the train's voyage, it could happen that, as soon as it re-passed the station, the station chief would have grown older by ten years, whereas the train conductor would have only aged by one year. The chronometers and calendars of the two men, not to mention their state of age of their organs, or the number of their heartbeats, supposing that they were counted, would testify as witnesses.

These were the fantastic unsuspected consequences of the logic of the Theory of Special Relativity. But what appeared shocking and mysterious to Mr. Painlevé in its consequences, was not that it offends common sense; it wasn't that some men aged really much less than others, simply because they voyaged so; no. What shocked him was not that, if I could say, voyages not only formed but prolonged youth; his analytical imagination had already, doubtless, made dreams more astonishing than that, and he knew that a world in which men could travel at speeds of tens of thousands of kilometers per second, relative to one another, would be a world very different from ours.

No, once again, what shocks Mr. Painlevé about these consequences, is something else; it is something that, at first glance, seems to him to go against logic; it is the following: When in the Theory of Special Relativity one considers two observers in relative motion, one always makes sure to specify that the appearances observed by each subject are reciprocal. If, for example, observer A sees the number of meters travelled and the clock

held by observer B respectively shrunk and slowed down by his speed, it will follow that observer B will see A's meters and held clock shrunk and slowed down by the same proportions. This results from the fact that the speeds of A in relation to B, and B in relation to A, are necessarily identical, and this reciprocity is in conformity with the classical principle of Relativity.

Is there not, asks Mr. Painlevé, an essential contradiction in all of this, in the fact that, in the chosen example, the station master sees that the express clock has slowed down compared to his own, while the train conductor sees, in agreement with the station master, that the station's clock runs early compared to his own? Shouldn't the reciprocity, which is commanded by the principle of Relativity, demand on the contrary that the train conductor sees the clock of the station run late relative to his? Besides, if that were the case, we would find ourselves with an absurdity, an impossibility, because it is contrary to common sense that if two men see clocks H1 and H2 at the same moment and at the same place, one can see H1 early relative to H2, and the other sees H2 early relative to H1.

How can we get out of all this, how can we escape from those difficulties, those contradictions that some might be tempted to consider as impossible?

Einstein's answer completely dissipated the misunderstanding because it is, as we shall see, only a misunderstanding, and, following his own expression, "brought to light the paradox." Here, reduced to its most important elements and freed from its technical terminology, is the way one could summarize the explanation of the great physicist, whose demonstrative evidence was—although a bit hidden—implicitly contained in the Theory of Relativity:

The Theory of Special Relativity exclusively concerns—my readers didn't forget it—systems in relative uniform motions to one another, that is, those systems which, in traditional mechanics, play a privileged role, and are the only ones to which can be applied the principle of Galileo's and Newton's classical relativity. But, it is convenient to recall, that the Theory of Special Relativity was first elaborated by Einstein for the purpose of enlarging and consolidating, if I dare say, this principle of Galilean relativity, with the intention of subjugating to it the optical and electromagnetic phenomena that seemed to rebel against it. Therefore, the equations of Einsteinian Special Relativity can only be applied to uniform motions, that is, to speeds constant in value and direction.

Thus, in the example which is the object of the debate, we could not consider the train, which goes to a certain place, stops, and then goes back, as in uniform motion. The sudden stop and return in an opposite direction constitute accelerations and perturbations of the train's movement, which momentarily ceases to be uniform, and then becomes uniform again, but in the *opposite direction*. Thus, even when considering the train only during moments when the speed is constant, it is clear that the same train on its outbound and return journeys does not constitute in reality the same reference system, but two different reference systems. As a result, the express train's clock, starting at the moment when the train reverses direction, must be adjusted anew to indicate the new proper time of the train, and the old adjustment must be modified to take into consideration the change of speed, because it is a change of speed when someone, relative to an observer, reverses the direction of

the moving object.

In a word, the train station, the departing train, and the returning train, really constitute, not just two, but three different systems, each having its proper time. It is not valid to suppose that the clock on the returning train could indicate the real time of the vehicle, if it did not receive other adjustments than those made when it departs the station. I propose to demonstrate this, with the following simple example: Let's suppose that another express train (let's call it Express 2) moves toward the train station, while Express 1, which we have considered until now, moves away from it with the same uniform speed. Let's suppose that the station's clock produces a light signal at precisely a quarter past noon, a signal from which Express 2 and Express 1 will synchronize their clocks. Each of the two train drivers sets his clock by considering the time taken by the signal to reach him from the station, which they consider as the distance from this station divided by 300,000 kilometers. But train driver 2 recognizes that his colleague from Express 1 made a mistake in this operation, because train driver 2 observes, while passing by Express 1, that the latter drives away from the light which, consequently, reaches him at a speed inferior and not equal to 300,000 kilometers. In consequence, train driver 2, if he had to fix his colleague's clock while passing by, would make a correction, which the latter did not take into consideration. This suffices to demonstrate that the clock on Express 1 would not be able to give indications comparable to the preceding ones, while he makes his return trip. Q.E.D.

But this only solves one part of the difficulty, and leaves untouched the one concerning the reciprocity of the vehicles' hourly indications. Respecting this point, the question in final analysis is posed thus: Since all motions are relative, shouldn't the result be the same, whether our express goes back and forth and the train station stays unmoved, or if we suppose our express stationary and the station going the distance back and forth? And, therefore why is it that the clock in the station, at the moment of the second intersection, runs early relative to that of the express, and not the other way around?

The answer is the following: In Special Relativity, only systems in uniform motion, in the Galilean sense of the term, show a reciprocity, from the standpoint of the measure of space and time, but it is not the same for systems in accelerated motion. This has been shown clearly since 1911 (at a time when Einstein had not yet developed General Relativity) by Mr. Langevin in a remarkable memoir on *The Evolution of Space and Time*.

In Special Relativity, all changes of speed, all accelerations relative to the environment in which light propagates, have an absolute direction. This is why, in this first theory, we cannot substitute the acceleration of our train when it changes speed, for an acceleration of the station in the opposite direction. Finally, this is why, between the indications from the station's clock and the one on the train, there is the dissymmetry that Mr. Painlevé has so appropriately brought to our attention.

At a time when we only knew of the Theory of Special Relativity, which gave an absolute value to accelerations in the Universe, as classical mechanics did, we had for a moment hoped to be able to demonstrate, through certain new electromagnetic experiments, the existence of a medium (let's call it ether if you wish) relative to which those accelerations were considered to exist.

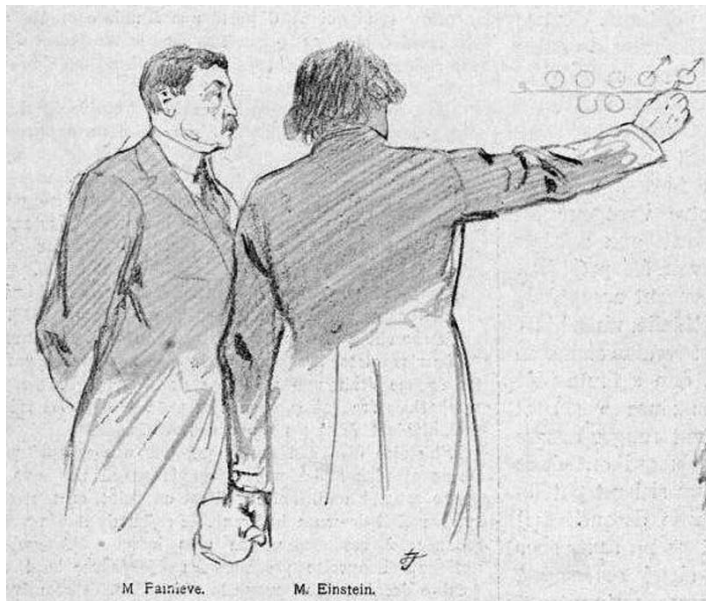

A drawing by Lucien Jonas of Einstein and Painlevé discussing the moving clock problem, on May 28, 1922.

But there was something in this that was shocking to the mind of Einstein. His ideas made him reject *a priori* the possibility of ever attaining an absolute space. This is why he called the “Theory of Special Relativity” the first step of his work, which applied only to uniform motions, wanting to indicate that it was only a first step towards total relativism of all motions.

The interesting and so suggestive discussion brought up by Mr. Painlevé on this particular subject and which represented the high point of the discussions at the Collège de France, had the benefit of demonstrating brilliantly the fact that the Theory of Special Relativity maintained certain privileged motions in mechanics and certain somewhat absolute axes of reference in the Galilean-Newtonian sense of the term. Some people had assuredly the tendency to forget that, but such had never been the case for Einstein.

When Einstein developed Special Relativity, his only purpose was to introduce electromagnetic phenomena under the principle of classical relativity. But he knew better than anyone else that this was only a first step. It was for the purpose of eliminating that last remnant of absolute space which still survived within Special Relativity that he tackled the gigantic problem of General Relativity. Here, there was no longer any privileged motion. Both uniform and accelerated speeds were united together in a grand synthesis and were obediently subjugated to a unique conception of universal phenomena.<sup>4</sup>

We just saw that the paradox mentioned by Mr. Painlevé can be explained quite adequately by Special Relativity itself, but only on the condition that we maintain an absolute value for changes in velocity, which is precisely one of the residues of ancient mechanics. It would be easy to demonstrate that in General Relativity, the paradox can be explained even more easily, and this time without preserving anything remotely resembling

absolute motion. But this demonstration would require more space than I have available, and besides, the question was not even brought up at the Collège de France.

\* \* \*

When the evening session of Wednesday April 5th opened, Mr. Langevin first asked that those who intended to intervene not speak longer than twenty minutes each. Twenty minutes, timed on my watch! he added amongst the laughs. We shall never know if this only alluded to the proper time of each system of reference, or if it was rather a consequence of the practical necessity of defining things by a possibly arbitrary, but univocal unit. The second hypothesis is less flattering for clock makers, but the first is quite difficult to admit. Because, if ever some observers were rigidly attached to one and the same system of reference, it is obviously those, who, that evening, sitting closely piled together in a continuous mass on the small steps of the amphitheater of physics, were coordinating all their minds’ tensors on unique axes all converging into Einstein’s brain.

After Einstein and Mr. Painlevé had reached an agreement on the concluding statement by Mr. Langevin; a concluding statement that I replicated above and which

was necessary to make in order to close the debate of the preceding session, the word was given for Mr. Edouard Guillaume, a Swiss physicist, to speak. In the previous days, most newspapers had published a wire announcing that this physicist had discovered blatant calculating mistakes in Einstein’s theory, and that he intended to reveal them, *coram populo*, [before the public] at the Collège de France. These mistakes would naturally lead to a complete collapse of Einstein’s synthesis, the total bankruptcy of this Law of Science. To be honest with you, all of those who had followed, with full knowledge of the facts, the series of analytical development of Einstein’s theory, those who knew that after a thorough study, Mr. Hadamard, the profound mathematician and successor of Henry Poincaré, had proclaimed that mathematically speaking, Einstein’s construction



Swiss physicist Charles-Édouard Guillaume (1861-1938), who received the Nobel Prize in Physics in 1920 for his discovery of anomalies in nickel steel alloys.



French mathematician Félix Édouard Justin Émile Borel (1871-1956).

4. See chapters V and VI of my little book: *Einstein and the Universe*.

had a most perfect and rigorous cohesion, without any logical flaw, or any formal defect; those, I say, were somewhat surprised by the news trumpeted in the press by the one who would, in no time flat, make mincemeat out of the poor Einstein.

Thus, Mr. Guillaume took the floor and started with a loud call to attention: "Ladies and Gentlemen." Then, he went to the blackboard where he had pinned some clever pink and blue graphics ahead of time, and he began to line up his formulas. After a few moments, it became clear to everyone that this was not going to be the day, nor the individual, that would force Einstein to bite the dust. When the orator was done, it had taken less than two seconds for those who had understood, and all the assistants agreed, to shrink back this loudly trumpeted intervention down to its modest proportions. It was Mr. Borel who interpreted the unanimous opinion (since the thing was so simple, that there was not a single elementary mathematics student who would not have been able to pass judgment) and declared that "the whole argument doesn't hold water, because it is not possible to first start by writing equations on Relativity and then introduce, solely by manipulating those equations, a series of foreign postulates which contradict the system." The error was so obvious, as it followed from the principle of homogeneity, that it was necessary to dismiss it with a one liner. Refuting a scientific construction by first introducing elements which it rejects, is easy, but it proves nothing. Speaking in his turn, Mr. Langevin concluded by



French mathematician Jacques Hadamard (1865-1963).

these textual words, which buttressed a demonstration that was as brief as it was clear, relative to a side issue: "The misunderstanding results from the fact that Mr. Guillaume does not understand what a light wave is." As for Einstein, smiling, he took refuge in a charitable abstention by pretending not to have understood anything his opponent was trying to say. This is how this more comical than painful incident ended.

We then returned to serious matters. Mr. Langevin first exposed how he had come to establish the formulas of the new dynamics by simply starting from General Relativity and the principle of the conservation of energy. I have previously sketched for this publication the astonishing consequences of the new mechanics which show us that mass—which classical science considered constant—increases and decreases with speed, and that energy is endowed with real inertia. I have indicated—you will recall—some of the stunning verifications that the physics of the atom and the electron have brought to these revolutionary conceptions.

Einstein took the floor to praise the beauty of the work that led Mr. Langevin to those results. He himself came to them independently, but through a much more complicated way that calls upon notions that are still somewhat unreliable and in which the famous quanta theory, this Chinese puzzle of today's

physics, was required. In one of his usual humorous and agnostic formulations, Einstein concluded: "It is thus that mechanics is profoundly changed by the not-yet-existing quanta theory."

Thus, ended the examination of the question raised concerning Special Relativity.

All that remained now, was to deal with the questions raised by General Relativity.

It was Mr. Hadamard, celestial mechanics professor at the Collège de France, who opened fire with a question relating to the formula by which Einstein expresses the new law of universal gravitation.

In this formula, under the simple form that Schwarzschild gave to it and that answers all the practical needs of astronomy, there exists a certain term that Mr. Hadamard is very much concerned with; if the denominator of that term becomes null, meaning if this term becomes infinite, the formula no longer makes sense, or at least one could demand what is its physical meaning.<sup>5</sup>

Mathematically this term cannot become infinite; but physically, practically, could it take place in nature? Not in the Sun's case, but possibly in the case of a star that would be infinitely more massive than the Sun.

Einstein does not hide the fact that this very profound question is somewhat embarrassing to him. "If," he says, "this term could effectively become null somewhere in the universe, then it would be an unimaginable disaster for the theory; and it is very difficult to say *a priori* what would occur physically, because the formula ceases to apply." Is this catastrophe—which Einstein pleasantly calls the "Hadamard catastrophe"—possible, and in this case what would be its physical effects?

I thought it would be useful to intervene at this point in the discussion, and I noted that, although we know of some stars much larger than the Sun (such as Betelgeuse, whose diameter equals 300 Suns), for the few stars whose masses we have been able to determine, we find that they are never much greater than the solar mass.

Additionally, it seemed to me from the works of the English astronomer Eddington, that when a star's mass has a tendency to increase more and more by gravitational attraction of outside matter, the internal temperature of this mass increases greatly and the radiation produced tends to throw outward (according to the Maxwell-Bartoli pressure) any new addition of matter, and to balance the attractive effect of gravitation. Therefore, it would be in the very nature of things that an insurmountable limit be reached in the increase of mass of a star. Such a star could never grow much greater than the mass of our own Sun. Therefore, the very physics of things would prevent the Hadamard catastrophe from ever happening, because the conditions of existence of stars that would have incomparably greater masses than the Sun could not be produced.

Einstein replied to me that he was not entirely reassured by

5. For the reader who wants more specifics, I allow myself to indicate that Einstein's gravity formula is the following:

$$ds^2 = dt^2(1 - a/r) - r^2(d\theta^2 + \sin^2\theta d\phi^2) - dr^2/(1 - a/r)$$

where  $ds$  is the geodesic element traversed in the universe by a gravitating point.  $r$  designates the radius vector of this gravitating point with respect to the mass's center and  $a$  is a length proportional to this mass and which, in the Sun's case, is equal to about 3 km. We see that when  $a$  becomes equal to  $r$ , the last term takes on an infinite value, and Mr. Hadamard is then asking what would actually happen in reality.



*Betelgeuse, in the constellation Orion, is the eighth brightest star in the night sky. Nordmann pointed out in the discussion that it has the diameter of 300 Suns, although he said that the few stars whose mass had been determined were never much larger than the Sun's mass.*

these calculations that involve several hypotheses. He would much prefer another means to escape "the misfortune which the Hadamard catastrophe represented for the theory." Effectively, in the following session of April 7th, he brought up the result of a calculation he had made concerning this fine point. Here is what this calculation shows: If the volume increases indefinitely without increasing its density (this would be the case for a sphere of water) it happens, well before the Hadamard catastrophe conditions could be met, that the pressure at the center of the mass becomes infinite. In these conditions, given the General Theory of Relativity, the clocks move at zero speed, nothing goes on, it is death; and therefore any new change capable of bringing the Hadamard catastrophe has become impossible. Einstein asked if it might not be the case that, following his expression, "the energy of matter is transformed into energy of space," that is to say, when mass is transformed into radiation. "That is all I can say," he concluded, "because I don't want to make hypotheses," which sounded like the very words of Newton. Mr. Hadamard in these conditions declared himself satisfied, and believed impossible the catastrophe so greatly dreaded.

Such was the discussion surrounding one of the most curious points which were raised at the Collège de France. All would agree that it did not lack taste, nor insightful penetration. It well

characterized the ideal atmosphere, saturated with an enthusiasm for pure truth and detached from the contingencies in which the now eternally famous controversies, took place.

During the last discussion session on April 7th, the question of the Hadamard catastrophe gave Mr. Painlevé the opportunity to ask Einstein some questions regarding his gravitational and similar formulas which now allow us to express new phenomena (the advance of the perihelion of Mercury, the deviation of light by gravity) observed in the fields of celestial mechanics and optics.

What followed was an extremely brilliant and sprightly discussion, at times so animated that everybody was speaking at once. At a certain point, while Mr. Hadamard and Mr. Painlevé were exchanging the most

spirited and contradictory arguments about the meaning of the stated formulas, we suddenly saw Mr. Brillouin (who had given up any attempt at inserting a single word edgewise between the rapid fire of the two antagonists) leap to the blackboard with a piece of chalk in his hand, and shout: "Since you are speaking, I will resort to writing; because the simplest way to make a quadrature is still to write it!" In this manner, he was able to capture the attention of a breath-



*French physicist and mathematician Marcel Brillouin (1854-1948).*

less public without the slightest unsealing of his lips. It was really a very beautiful battle and a rewarding sport event. Moreover, the two adversaries were vying in courtesy with each other somewhat aggressively, and we could hear, at a certain point, Mr. Painlevé shouting at Mr. Hadamard: "I can't see how the discussion can benefit anyone by being conducted in this manner; but go on, I beg of you"; and the next moment, he apologized by saying: "Please forgive me for not making myself clear, but..." While all the written and spoken arguments dashed and clashed against one another, quickly and sharply filling up the room with tumult, and the board with elegant integrals with their necks inclined like white swans, Einstein sat in the middle of the tempest, smiling and remaining silent.

Then, suddenly raising his hand as a schoolboy requesting the teachers attention: "May I also be permitted to say a little something?" he asked softly. Everybody laughed. Einstein spoke in the now restored silence, and within a few minutes everything was made clear. I believe this is how one can summarize the essential points provided by Einstein and which definitely settled the main objections raised.

Above all, people wanted to know what the quantities of Einstein's gravitational formula represented, and especially the radius vector, that is to say, the line joining the Sun to each planet.

Newton's law, the foundation of all traditional celestial mechanics, expresses a relation linking the masses of two stars (or celestial bodies) and their distance. Let's leave aside, to not overload this exposé, all that concerns the mass and let's con-



sider only their distance. In order to make exact calculations, we must specify at which moment we consider the distance. Classical science, with its *a priori* notion of a universal and absolute time, ignored this difficulty and, if considerable mistakes did not follow, it was only because of the slow speed of the planets relative to the speed of light. Moreover, when classical astronomers determine by triangulation the radius vector of a planet, and translate their design on paper, they trace a rectilinear triangle, a Euclidean triangle, because they suppose that their line is rigorously straight. But since light is slightly curved by gravity, it is not. Thus, small but necessary corrections are to be made when we want to define the line linking two celestial bodies, of which classical science was unaware. Moreover, classically, it was supposed that the radial vectors were measured with identical rulers lined up from end to end, and whose lengths were supposed to be the same. There again, we did not do the necessary correction that follows from the apparent contraction of the rulers caused by speed, due to the particular propagation of light rays.

In a word, the magnitudes which are used in the new law of gravitation are concrete magnitudes. For example, the radius vector joining a planet and the Sun must be considered to be marked out by identical rulers (naturally assumed to be subject to elastic and thermal deformations) aligned in the direction of the line of sight, stationary with respect to fixed stars, and subjected to the gravitational action of the Sun. When a stone is thrown in the air, at the instant when it ceases to ascend and is about to begin to fall, it is entirely subjected to the effects of gravity. The rulers that constitute the radial vector under consideration must be considered as being in an analogous situation. To these rulers are supposedly attached identical clocks which are, also, ideally subjected to the action of the Sun. Under these conditions, the astronomical data are defined in a perfectly concrete and objective manner. "There is nothing left but rulers and clocks, there are no longer observers, and all that is subjective has been eliminated."

This is, to use Einstein's expression, a certain "absolute" manner of defining measured magnitudes in astronomy, since it is no longer necessary to relate it to a particular observer.

Such are the concrete, objective, measurable quantities which enter, without ambiguity, into Einstein's gravitational formula. By this mathematical metamorphosis, by these changes of variable that are called point transformations [mappings], we can certainly find other more or less different formulas for gravitation, but these transformations change nothing of the observable and objective things as we have just defined them.

There is, therefore, for Einstein, only one unique formula establishing an unambiguous relationship between measured quantities: it is that which Mr. Painlevé called ironically "the classical formula, the already classical Einsteinian formula of gravitation."

In a word, it is always better to give a measurable meaning to symbols that are introduced in formulas, and to never lose sight of the physical significance of these symbols: a physical significance which does not objectively change when the symbols have been transformed.

These same remarks are applicable to the interesting observations that were presented, at the end of the session, by a distinguished mathematician Mr. Leroux. Here, once again, Ein-

stein strongly insisted on underscoring the fact that the only geometrical figures that he considers in space are those really traced out with rulers, and not the idealized figures of the purely formal geometries.

"We can always define," he concluded, "but we must define physically."

Thus, the cycle of these memorable discussions was concluded. And if, as stated by Mr. Langevin in closing them, we had not tackled all of the questions that could have been raised, at least, all of the questions posed received a satisfactory answer.

The theory of Einstein emerged from this tournament entirely unscathed, and Einstein himself came out of it greater than before. As Mr. Painlevé related to me with a most appropriate illustration, the work of the famous physicist stood firm like a perfectly coherent and inflexible granite block that did not have a single flaw. Relativity is a brick whose cohesion cannot be impaired, a system without logical contradiction, free of all ambiguity, and without any internal defects.

However, even though he conceded on the details, Mr. Painlevé still refused to accept the doctrine as a whole. He was incapable, as he confessed, of taking down such a majestic and practical edifice as that of classical science. For him, if I dare say, the cube rests on its vertex; for others, myself included, it rested unshakable on its base. Everyone can, depending on his inclinations, either distance himself with prudence, as one does when passing under an overhanging ledge, or on the contrary, make use of it as a pedestal capable of supporting an exact image of the world.

\* \* \*

The discussion session that was held at the Sorbonne, on Thursday, April 6th, under the auspices of the French Philosophical Society, was not in any way to be dismissed as being of lesser importance than the physical-mathematical controversies at the Collège de France.

Although the philosophers already had the opportunity to discuss the Theory of Relativity, notably with Mr. Langevin, "the apostle of this new gospel," they nevertheless were quite numerous at this meeting, where the discussion was to take place in the presence of the monster himself.

After a good opening address from the President of the Society, Mr. Xavier Léon, the debate got started with a profound and remarkable exposé by Mr. Langevin which could have been entitled: "Why philosophers should be interested in the Theory of Relativity." The knowledgeable physicist described with masterful clarity the key elements of methodology and epistemology that established the strength and appeal of Einstein's work.

Some day, I plan to return to this penetrating commentary on relativity given by the French scientist who best mastered it. It deserves better than a summary of a few lines.

The discussion that followed, and in which a number of mathematicians participated, made it clear that, strictly from the standpoint of logic, the entire doctrine of relativity was coherent, and was free of any internal contradictions. This had already been the implicit conclusive assessment from the discussion at the Collège de France.

After the mathematicians, the physicists entered in turn into the discussion, introducing diverse questions posed distinctly, which led Einstein to give his opinion on several very interest-



The Albert Einstein Archives, Hebrew University, Jerusalem

*Einstein at the blackboard during his 1922 lecture at the Sorbonne in Paris.*

ing points on cosmology, on geometry, and notably on the quadrature of the circle. I will come back to this in a few days.

Following the scientific community, the philosophers took their turn at asking Einstein a number of questions. The ghost of Kant having been evoked, Einstein did not hide the fact that he was definitely opposed on several points to the ideas held by the Königsberg philosopher, for whom absolute space and absolute time were *a priori* notions already existing inside of us. The Theory of Relativity asserts the opposite, and, better yet, demonstrates it.

Even though Einstein might otherwise have some admiration for Kant, he apologized for having a somewhat personal view of Kantian ideas by saying: "Every man has his own Kant," (a statement which, another argued had been a pun dating back to ... Plato), but by stating in jest: "Every man has his proper Kant."<sup>6</sup> This gains its fullest meaning when we remind ourselves that: "proper time" is one of the



*French philosopher and historian of philosophy Xavier Léon (1868-1935).*

mother concepts of relativity. Einstein remarked elsewhere that two ways of conceiving things in the most opposite way imaginable is either from the standpoint of Kantian a priorism, or from the standpoint of Poincaré's convenience principle. "All I can say," added Einstein, "is that between these two lines of thinking, one has to choose according to experience." We presume that he doesn't consider the kind of experience that would be favorable to the a priorism of Kant to be of great interest.



*German philosopher Immanuel Kant (1724-1804). "Every man has his own Kant," Einstein quipped.*

Finally, after a remarkable exposé by Mr. Le-Roy, Mr. Bergson was asked to speak. He recounted in his usual engaging and pictorial way,

his own ideas of the notion of time, that he had, as we know, so profoundly pondered. The Bergsonian time, which, if I may be so bold to say is a sort of "proper time of our soul." This feeling of our inner passage is also, in some way, the feeling of the flow of our enviring matter. Our surroundings coincide with the fluidity of our inner life. But where does the extension of our surroundings end? Very far from us, we can imagine other consciousnesses, as links across the universe, and beyond these links, a sort of universal consciousness, that would be as their integral, and toward which the totality of the phenomena would be flowing. Thus, the Bergsonian notion of duration would be dissolved in the end into a sort of universal time. Mr. Bergson wishes to believe that there is no antagonism between this manner of seeing and the relativistic conception of time. If we cannot demonstrate the concordance of the two conceptions, we could not, without a doubt, determine their discordance. Mr. Bergson thinks besides this that there could be an incommensurability between purely qualitative intuitive time, and quantitative relativistic time. In conclusion, he doubted that Relativity would be able to completely ignore the intuitive point of view, especially when it involves the notion of simultaneity of the phenomena in which he estimated that our sensations have a role to play, one way or another.

In his response to the points raised above, Einstein does not share in any of the viewpoints of Mr. Bergson. He maintains that the time of the philosophers cannot differ from the time of the physicist: It is the same. One needs validation, assuredly, in the definition of time, starting with intuitive time, which is the sentiment of the order that is given to us and in which our states of consciousness proceed in succession. Two individuals who are in agreement with each other already constitute a first step towards a sense of objective time; because—at least, Einstein affirms that he is convinced—, there are objective events which are distinct from subjective events. As far as the "simultaneity" of

6. [Translator's note] "Chacun à son Kant à soi," or "Chacun a son Quant-à-soi" could be heard as "Everyone has his own Kant" or "Everyone has his own reservations." "Quant-à-soi is an expression meaning to be reserved, not expressing your feelings or your ideas.

two events is concerned, Einstein recalled that, for a long time, they were considered practically the same for two neighboring individuals, because of the great magnitude of the speed of light. But, when we analyze that notion more closely, and take into account that the propagation of light, as rapid as it is, is not instantaneous, we come to the conclusion of Relativity: that simultaneity is a notion that varies from one observer to another. According to Einstein, there is nothing in our consciousness which indicates to us the simultaneity of the contemporaneity of events: these are logical concepts, not psychological concepts, and they are immediately given. If the philosophers are able to conceive of an abstract time, a sort of extrapolation of their state of consciousness, there is, as well, an abstract time for the physicists: It is the absolute time of classical science. In a word, Einstein thinks that the philosophers don't have their very own time.

This does not mean that the Theory of Relativity is incompatible with the Bergsonian conception of time. Einstein believes that any reasonable philosophical system, that is to say, that which is a coherent system, is always necessarily in accord with natural and physical science. Here we have the independent variables, as the mathematicians say.

In short, a scientific theory is not a philosophy, but it is something which philosophy must take into account. If the Theory of Relativity is exact, any consistent philosophy will have to put itself in agreement with it; but by itself, it doesn't constitute a philosophy.



Emile Meyerson (1859-1933) was a Polish-born French chemist and philosopher of science.

In response to a question which was posed by Mr. Meyerson about the ideas of Mach, Einstein was led to give more precision to his conception of science. Although he agrees with Mach that scientific concepts must always agree completely with observable data, he refuses to admit that science only consists of simple relationships between the facts. For him, a science is a system, that is to say, a logically deduced synthesis, not simply a "catalogue" of facts, as Mach would claim.

\* \* \*

And now let us endeavor to conclude. Of all these discussions in which passion was not at all absent—and that pleased Einstein, because he knew that you only push on something that offers resistance—of all these intellectual shocks where the calm mastery and lucid logic of the new Newton evinced itself, the Theory of Relativity came out intact.

In order to summarize the results of the controversy, it seemed to me that the best way was to make use of Socrates' method of midwifery. Here you have those questions which, I think, can be asked in order to specify the most important points.

1. Is it true that the Theory of Relativity, maintains all the ancient and confirmed results from classical science and, in particular, of mechanics and astronomy? Is it true, consequently, that renouncing the classical model in order to adopt the Einsteinian model, is in no way a renunciation of any of the least solid conquests of the former?

2. Is it true that to these acquired results, that it incorporates and preserves, Relativity is adding new results which it has foreseen, which classical science had not foreseen and could not have foreseen, and which have been experimentally verified?

3. Is it true that Relativity, in a unique synthesis, unites domains, like mechanics and gravitation, and like optics and mechanics, which used to obey disparate and sometimes irreconcilable laws of classical science?

4. Is it true that the principal criterion for the value of a scientific theory is the principle of simplicity, and that among all the possible theories of the same phenomena, the one which applies the least number of hypotheses and which eliminates the greatest number of occult and non-measurable assumptions, is preferable? Is it true that in this regard, classical science is not on par with the Theory of Relativity?

5. Is it true that Relativity explains certain facts which seem contradictory in classical science and which the latter has not yet succeeded in explaining?

If all this is true,—and who could think otherwise—we must logically conclude that the Theory of Relativity is the only theory which gives a complete representation and an explanation of known facts, and which has allowed us to go further still in foreseeing new phenomena.

Never before has the human spirit crafted a framework more magnificent in its simplicity, and more exactly attuned to the nature of reality, from which to understand the mysterious image of the world. Never has the eternal sphinx been enchained by links more solid, more supple, and which follow with such harmonious precision, the lines of its superb and deceptive body.

\* \* \*

And yet .... And yet, beyond the penetrating, subtle, and scholarly questions that were asked in these recent discussions, no one thought of raising a few others which seem particularly troubling to me. One day, when Einstein scolded me in a friendly way for "the flowers" that my admiration had sometimes lavished on his work, I promised him to always have henceforth some criticisms mixed-in. In order to be faithful to that promise, but above all because it is important to never forget that every human work is perfectible, I ask permission to present here some remarks that I did not think should have been brought up at the Collège de France, because they could not have resulted in any positive or negative assertion, but only in a feeling of doubt.

The essential experimental foundation of Relativity resides in the contradictory facts that the Michelson experiment and analogous experiments have displayed. These facts correspond with other explanations besides the Einsteinian one. Whether we acknowledge the reality of the Lorentz contraction (and the fact that all bodies are composed of electrons makes this hypothesis acceptable), or whether we return to a possible new emission theory of light, or whether we accept the existence of an accompanying flow of Lorentz's ether in the neighborhood of massive bodies; the fundamental facts of Relativity imply other explanations of that theory. Granted, the researchers, if there are any, have yet to bring us results. But the simple fact that these other explanations are *a priori* conceivable, makes an experimental departure from the Theory of Relativity a debatable proposition.

In a word, the disconcerting facts which are at the foundation of the theory of Einstein can have other results than that theory.

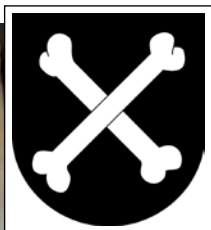
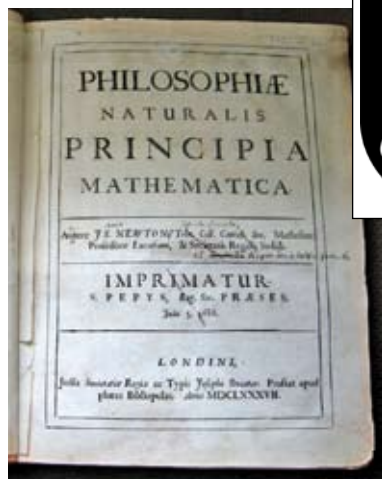

*Newton's view of absolute time and space, expressed in his 1686 Principia, was overturned by Einstein. Inset is the personal coat of arms of Sir Isaac Newton.*

There are certainly very strong arguments that lead us to reject the "absolute space" of Newton *a priori*. But if the privileged space of classical science is nothing but the immovable ether of Lorentz, one can reconcile the relativist's agnosticism with this ether, and save the principles by assuming that our whole Universe is a beautiful bubble of movable ether in an etherless assemblage.

In a word, the experimental starting point of Relativity can appear less solid than its experimental end point, itself, marvelously powerful, which rests on the astronomical and optical observations that everyone knows. Classical celestial mechanics will have to undergo a readjustment in order to adapt itself to these novelties, but it is nowhere demonstrated, *a priori*, that this readjustment could not be accomplished within the framework of the old system based on the ether of Lorentz.

I know that none of these arguments are very convincing; that so far they have merely been defeats. But, the mere fact that they suggest the possibility that conclusions other than Einstein's may be drawn from the experimental facts, gives us the right to reserve judgment, until all the other attempted theories, which are bound to be made, have been proven false.

However, be that as it may, there is still something infinitely troubling in the Einsteinian system. This system is admirably coherent, but it rests on a particular conception of the propagation of light. How are we to imagine that the propagation of a ray of light could be identical for an observer who flies away from it, and for an observer who rushes forward to meet it? If this is possible, it is in any case inconceivable to our customary mentality, and no matter how hard we try, we cannot make the mechanism and nature of that propagation intelligible.

It must be confessed that here lies a "mystery" which eludes us. The whole Einsteinian synthesis, as coherent as it is, rests on a mystery, exactly like the revealed religions. Classical science at least appeared to be based on clear and simple notions. We are now told that they never existed, or, at least, that they were merely metaphysical. The future will tell whether or not we will be able to re-establish them in their reality, by means of the Lorentzian ether, and of the non-absolute, but privileged space, that it may define.

If that occurs, the founding notions of classical science will cease to be metaphysical; but today, as metaphysical as they

may be, they seem clear and conceivable, if not measurable. On the contrary, the Einsteinian notion of the propagation of light still remains inconceivable.

Certainly, there has to be some profound, substantial reality, which is subtly concealed in the still elusive role played by the number expressing the invariable speed of light. This must be the case, simply judging from the stunning and verifiable consequences that Einstein has been able to derive from this mysterious foundation.

Simply said, the foundations of classical science lie beyond the grasp of our senses, but not beyond the powers of our imagination; while the basis of the Einsteinian doctrine is, on the contrary, perceptible, though unimaginable. Therefore, we would be justified in hesitating to choose one over the other. But, a comparison of the construction of the two systems, their respective volumes, and the unequal vastness of horizons that they open upon the universal landscape, necessarily forces us to lean toward the latter.

The theory of Einstein is a marvelous tree that has grown farther and higher than any other ideal flowers of human thought. Similar to the palm trees of the Wadi in the Sahara, this singular tree emerged from a shadowy well, in which invisible life-giving water sings...



*"The theory of Einstein is a marvelous tree that has grown farther and higher than any other ideal flowers of human thought," Nordmann concludes. Here, Einstein in Berlin in 1922.*